

RainDrain Compact
Complete set shower drain 900 for flat installation
 Finish: **Brushed Stainless Steel** Article Number: **56168800**



Description

product features

- consists of: finish set shower drain, installation set, siphon, grate removal tool, pre-assembled sealing membrane
- pre-assembled sealing membrane
- water seal: 30 mm
- connection diameter: DN40
- direction of outlet: horizontal
- easy to clean surface
- height adjustable installation set
- up to 27 l/min drainage capacity
- where to use: renovation, new construction
- tile thickness: up to 18 mm
- suitable for every type of tile and tile thickness
- removable water lock
- easy to clean siphon
- grate removal tool allows easy removal of the finish set
- type of odour seal: fluid
- minimal installation height 43 mm
- Basic set height: 30 mm
- material siphon: ABS
- mounting type: free in the floor
- grate material: Stainless Steel 304 (1.4301)
- suitable for primary drainage

Technology



Product image



Scale drawing

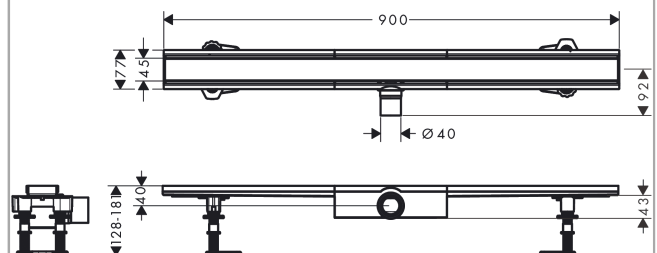

RainDrain Compact
Complete set shower drain 900 for flat installation
 Finish: **Brushed Stainless Steel** Article Number: **56168800**



Exploded Drawing

Year of production: >01/23

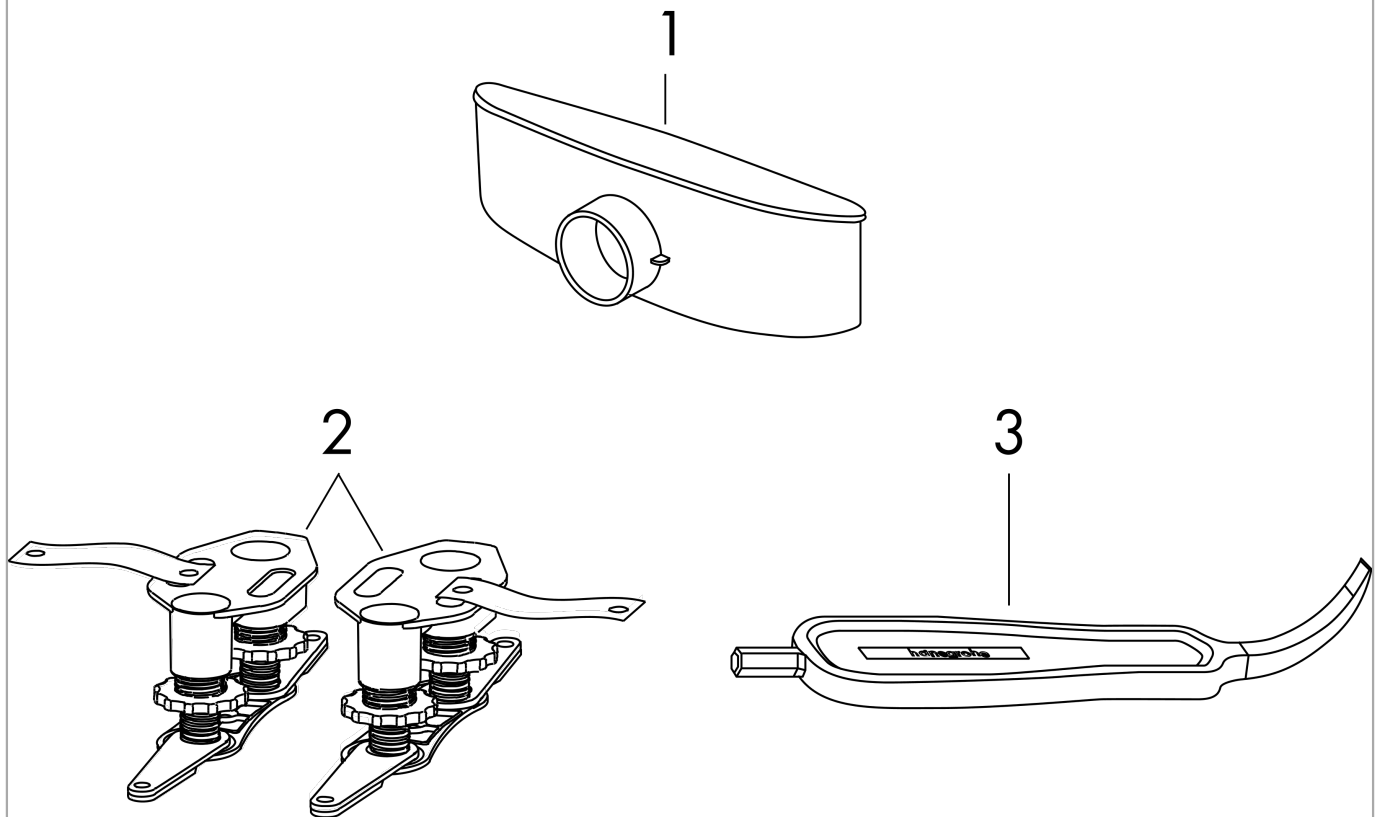

RainDrain Compact
Complete set shower drain 900 for flat installation
 Finish: **Brushed Stainless Steel** Article Number: **56168800**



Spare part list

Year of production: >01/23

Pos.	Description	Article Number	PC	PU
1	trap cpl.	94755000	0	1
2	mounting-set	94331000	10	1
3	service tool	94327000	7	1